











PART NO 5040018, 9110018

VT FRONTFIX/FRONTFIX MINI

-  L: 80 mm
-  W: 40 mm
-  H: 600/410 mm
-  1,9/1,4 kg
-  Steel + Zn (hot dip galvanized)
-  EN13374 – A

-   1,24 × 0,84 × 0,97 m
-  745/665 kg
-  350/450 pcs

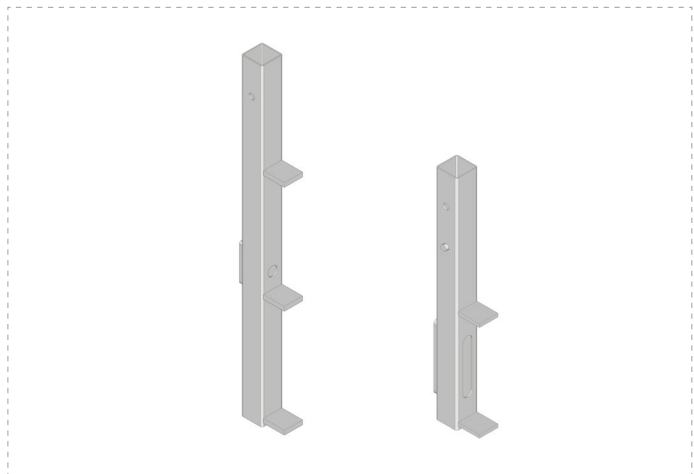

5040018

9110018

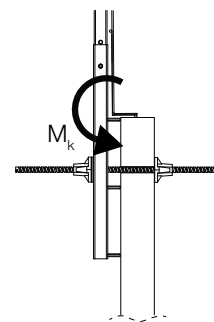
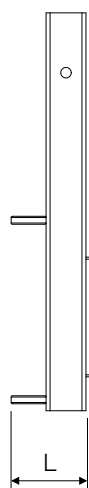
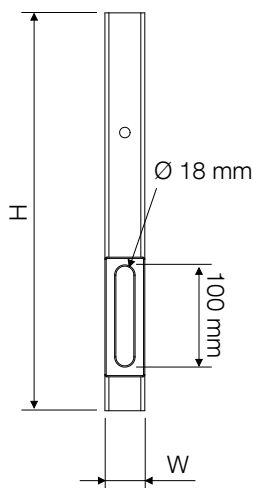
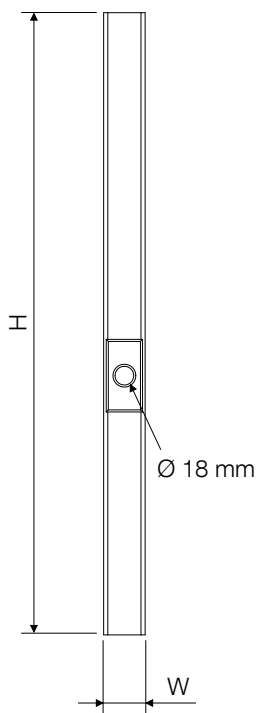

BENDING MOMENT (Q) ¹ (Unfactored)	
M _k	690 Nm
¹⁾ Loads acc. to EN 13374:2013 $Q_{kl} \times \gamma_F^* = E_d \leq R_d = R_k / \gamma_M (k_{mod}^{**})$ [*] $\gamma_F = 1,5$ ^{**} for timber	

